

# Yacht Devices

## User Manual

NMEA 0183 Gateway YDNG-03

**also covers models**

YDNG-03R, YDNG-03N

**Software version**

1.03

**2018**

© 2018 Yacht Devices Ltd. Document YDNG03-002. August 7, 2018. Web: <http://www.yachtd.com/>



Yacht Devices NMEA 0183 Gateway YDNG-03 is certified by the National Marine Electronics Association.

NMEA 2000® is a registered trademark of the National Marine Electronics Association. SeaTalk NG is a registered trademark of Raymarine UK Limited. Garmin® is a registered trademark of Garmin Ltd.

## Contents

Introduction .....	4
Warranty and Technical Support .....	5
I. Product Specification .....	6
II. NMEA Basics .....	8
III. MicroSD Slot and Card's Compatibility .....	12
IV. Installation and Connection of Device .....	13
V. LED Signals .....	15
VI. Device Settings .....	17
VII. Recording of Diagnostics Data .....	24
VIII. Firmware Updates .....	27
IX. Autopilot Control and Settings .....	29
Appendix A. Troubleshooting .....	32
Appendix B. Device Connectors .....	33
Appendix C. NMEA 2000 Messages Supported by Device .....	35
Appendix D. Conversions Between NMEA 2000 and NMEA 0183 .....	37
Appendix E. Example of Configuration File .....	44

## Package Contents

Device	1 pc.
This Manual	1 pc.
Stickers for MicroSD slot sealing	6 pc.

## Introduction

The NMEA 0183 Gateway (hereinafter Gateway or Device) allows you to connect NMEA 0183 equipment to a NMEA 2000 network and vice versa. It has a bi-directional converter with wide support of message types including AIS (see Appendix D) and autopilot control.

The Gateway has one NMEA 2000 connection and one NMEA 0183 port with transmit and receive data lines. The configurable baud rate from 300 to 115200 baud of NMEA 0183 port allows connecting AIS transceivers (38400 baud), fast NMEA 0183 multiplexers and PC adaptors, as well as standard NMEA 0183 equipment. Both “single ended” and “differential” NMEA 0183 connections are supported (see Section II.1).

The Device is equipped with a Micro SD card slot used for configuration, firmware updates and diagnostic data logging. No special software is required to update or configure the Gateway. You only need a device (laptop or smartphone) with a MicroSD card reader and simple text editor.

A flexible system of filters allows blocking of NMEA 0183 messages by sentence (see Section VI.2) and NMEA 2000 messages by PGN, sender address, or 29-bit message identifier. Filters also allow blocking of all messages in a specified direction (see example in Section VI.4).

The separate filter defines what NMEA 0183 sentences should be forwarded from the NMEA 0183 input to the NMEA 0183 output. This turns the Device into a multiplexer of NMEA 2000 and NMEA 0183 data, and allows using it as a repeater or extender of the physical NMEA 0183 uplink. Multiple “listeners” can be connected to the NMEA 0183 output (TX) lines of the Gateway.

The Gateway is powered from the NMEA 2000 and provides high voltage galvanic isolation between NMEA 2000 and NMEA 0183 ports.

Thank you for purchasing our product and happy voyages!

## Warranty and Technical Support

1. The Device warranty is valid for two years from the date of purchase. If a Device was purchased in a retail store, the sales receipt may be requested when applying for a warranty claim.
2. The Device warranty is terminated in case of violation of the instructions in this Manual, case integrity breach, or repair or modification of the Device without the manufacturer's written permission.
3. If a warranty request is accepted, the defective Device must be sent to the manufacturer.
4. The warranty liabilities include repair and/or replacement of the goods and do not include the cost of equipment installation and configuration, or shipping of the defective Device to the manufacturer.
5. Responsibility of the manufacturer in case of any damage as a consequence of the Device's operation or installation is limited to the Device cost.
6. The manufacturer is not responsible for any errors and inaccuracies in guides and instructions of other companies.
7. The Device requires no maintenance. The Device's case is non-dismountable.
8. In the event of a failure, please refer to Appendix A before contacting technical support.
9. The manufacturer accepts applications under warranty and provides technical support only via e-mail or from authorized dealers.
10. The contact details of the manufacturer and a list of the authorized dealers are published on the website: <http://www.yachtd.com/>

## I. Product Specification

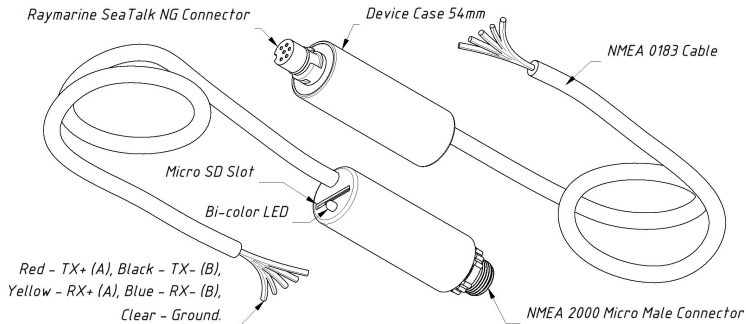



Figure 1. Drawing of YDNG-03N (left) and YDNG-03R (right) models of Gateway

Our devices are supplied with different types of NMEA 2000 connectors. Models containing R in the suffix of model name are equipped with NMEA 2000 connectors and are compatible with Raymarine SeaTalk NG. Models containing N in the suffix are equipped with NMEA 2000 Micro Male connectors. See connector drawings in Appendix B.

<b>Device parameter</b>	<b>Value</b>	<b>Unit</b>
Current consumption from NMEA 2000 network	30	mA
Supply voltage from NMEA 2000 network	7..16	V
Load equivalency number	1	LEN
NMEA 2000 Connections	1	—
Galvanic isolation between NMEA 2000 and NMEA 0183	2500	V <sub>RMS</sub>
NMEA 0183 Cable length	400	mm
NMEA 0183 Ports (input / output)	1 / 1	—
Device case length	54	mm
Weight	37	gr
Operating temperature range	- 20..55	°C

*Note:* the Gateway is powered from the NMEA 2000 network.

 Yacht Devices Ltd declares that this product is compliant with the essential requirements of EMC directive 2004/108/EC.

 Dispose of this product in accordance with the WEEE Directive. Do not mix electronic disposal with domestic or industrial refuse.

## II. NMEA Basics

This section describes the basics of NMEA 0183 and NMEA 2000 networks. We are recommend getting familiar with this section before connecting the Device.

These networks are very different at the electrical and software levels. NMEA 0183 also has traveled a long evolutionary path, but thanks to its simplicity and cheapness, it is still very popular and widely used.

### 1. NMEA 0183

The default speed of a NMEA 0183 interface is 4800 baud. A high-speed interface is 38400 baud and was designed especially for AIS, but usually chart plotters and instrument displays allow any data (not only AIS) on a high-speed port. On a chart plotter, port speed can be configured in settings.

NMEA 0183 uses different wires for talking (transmitting, TX) and listening (receiving, RX) data. One talker can be connected to multiple listeners, but a listener can have only one talker connected. Special devices called “multiplexers” are used to join the output of multiple talkers to a single stream.

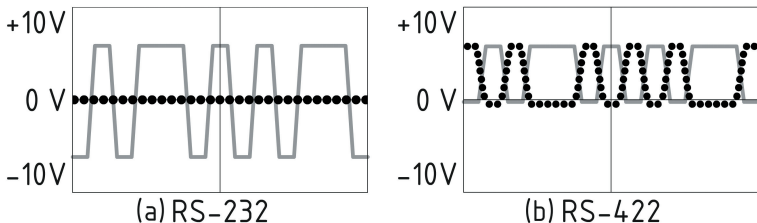

Figure 1. (a) RS-232 and (b) RS-422



NMEA 0183, until version 2.0 (1992), used a “single ended” RS-232 interface with one TX line and one RX signal line (grey at Figure 1.a) and ground line (dotted at Figure 1.a) used as reference for TX and RX signals. Therefore, old devices have only three wires.

Since version 2.0, NMEA 0183 has been based on a “differential” RS-422 interface, which has two RX lines RX+ (can also be marked as “A”) and RX- (or “B”), two TX lines TX+ (or “A”, grey at Figure 1.b) and TX- (or “B”, dotted at Figure 1) and ground (not shown at Figure 1.b). Modern devices use five wires.

Devices of different versions can be connected, but with one caution. TX- (“B”) is not equal to a ground line. Voltage on the TX- line (dotted on Figure 1.b) changes from 0 to 5V, and connecting this line to ground line can cause a short circuit.

The right connection schemes are shown in Figure 2.

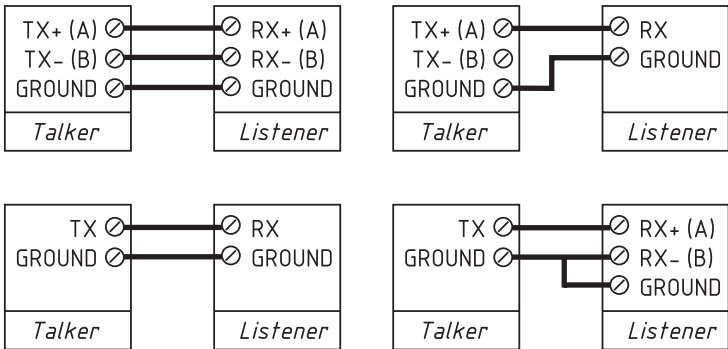

Figure 2. Connection of NMEA 0183 devices

## 2. NMEA 2000

NMEA 2000 network runs at 250 kbps and allows up to 60 physical devices to be connected. Unlike NMEA 0183, there are no “talkers” and “listeners”. All devices can “talk” and all devices receive all messages. Many electronic manufacturers presented “branded” versions of NMEA 2000. Raymarine SeaTalk NG, Simrad SimNet, FurunoCAN differ only in the type of connectors used. However, in recent years manufacturers have been moving to NMEA 2000 connectors.

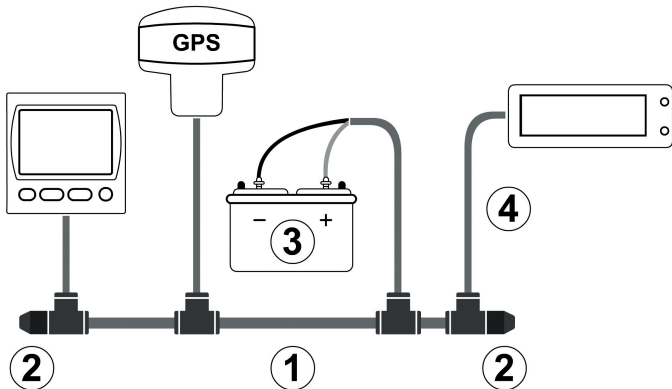

Figure 3. Basic NMEA 2000 network (1- backbone, 2 – terminators, 3 – dedicated power, 4 – drop cable)

The network backbone (between 2 and 2 at Figure 3) has two data lines (called CAN HIGH and CAN LOW) and two power lines. Power lines should be connected to a 12-Volt power supply (see 3 at Figure 3). Low-powered devices, like our Gateway, take power directly from the network backbone.

Data lines are “terminated” at both ends with a 120-Ohm resistor (see 2 at Figure 3). Therefore, resistance between CAN lines is between 60 and 120 Ohms. Devices can be connected to any place of backbone (between terminators). The cable from network backbone to the Device is called a drop cable (see 4 at Figure 1). Our devices can be connected directly to a backbone.

All the above does mean that you can not simple connect the Gateway to a NMEA 2000 port of your chart plotter to connect a NMEA 0183 sensor to it. You should establish a simple NMEA 2000 network first. Many manufacturers offer a “Starter Kit” which contains all that is necessary to establish a basic network and connect two devices:

- for Raymarine SeaTalk NG, see Raymarine part number T70134;
- for NMEA 2000, see Garmin part number 010-11442-00.

### III. MicroSD Slot and Card's Compatibility

The Device has a slot for a MicroSD card that allows you to configure the Device (see Section VI), update the firmware (see Section VIII) and record diagnostics data (see Section VII).

Since the MicroSD slot is usually not in use when the Device is working, we recommend sealing it with the sticker that is included with the Device or with a piece of tape to prevent water from entering the Device through the slot.



*The Device slot has a 'push-push' mechanism that works on a spring and ensures proper card fixation. Improper loading or unloading (withdrawing your finger to quickly or not waiting for the click) can result in the card being propelled out of the Device up to 5 meters. To avoid possible eye injury, loss of or damage to the card, and other hazards, insert and remove the card with caution.*

The Device supports MicroSD memory cards of all sizes and classes. The MicroSD card must be formatted on a personal computer before use in the Device. The Device supports the following file systems: FAT (FAT12, FAT16, MS-DOS) and FAT32. It does not support exFAT, NTFS, or any other file systems.

Be careful when inserting the MicroSD card into the Device. The card is inserted with the label side toward the LED and with the pin side toward the NMEA 0183 cable.

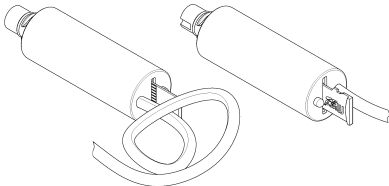

*Figure 1. Device with MicroSD card (pin side visible at left, label side at right)*

## IV. Installation and Connection of Device

The Device requires no maintenance. When deciding where to install the Device, choose a dry mounting location. Avoid places where the Device can be flooded with water, as this can damage it.

### 1. Connection to NMEA 2000

The Device is directly connected to the NMEA 2000 network backbone without a drop cable. Before connecting the Device, turn off the bus power supply. Refer to the manufacturer's documentation if you have any questions regarding the use of connectors:

- SeaTalk NG Reference Manual (81300-1) for Raymarine networks
- Technical Reference for Garmin NMEA 2000 Products (190-00891-00) for Garmin networks

After connecting the Device, close the lock on the connection to ensure its water resistance and reliability.

The Device is powered from the NMEA 2000 network and has an LED which flashes red or green. After turning the power in the NMEA 2000 network on, the Device's LED will give a one green flash indicating that it is turned on and then series of 6 flashes 5 seconds apart. If this does not happen, see Appendix A.

You can also check the NMEA 2000 connection and firmware version from a chart plotter. Please see Section VIII for details.

### 2. Initial configuration

The Gateway is supplied with a NMEA 0183 port configured for 4800 baud. If your NMEA 0183 equipment has a different speed, it is recommended to configure the Gateway port speed before connecting to NMEA 0183 equipment (see Section VI.1). If your NMEA 0183 equipment supports port speed configuration, it is recommended initially to set the highest available speed at the Gateway and equipment.

Note that the Gateway has a bi-directional converter between NMEA 0183 and NMEA 2000. This can cause flooding of the NMEA 2000 network by unwanted data from NMEA 0183 and vice versa. You may configure the Gateway to work in one direction only if required (see Section VI.4).

### 3. Connection to NMEA 0183



*The connection to the NMEA 0183 network varies depending on the version of the connecting equipment. Please, refer to Section II.1 for connection schemas. The wrong wiring can damage the equipment!*

Note that many NMEA 0183 devices, including the Gateway, have different wire colors than specified in the Standard. Please check the label on cable and/or documentation before connecting.

*Table 1. NMEA 0183 Wire Colors*

<b>Signal</b>	<b>NMEA 0183 Standart</b>	<b>Gateway YDNG-03</b>
Talker TX+ (A)	White	Red
Talker TX- (B)	Brown	Black
Listener RX+ (A)	Yellow	Yellow
Listener RX- (B)	Green	Blue
Ground	Black	Clear

All connections should be made when the power is off. This will protect against accidental short circuits during installation.

The wires are recommended to be connected by crimping in sleeves or twisting rather than soldering. Soldered connections can quickly break down in the marine environment and require isolation from air with paint or lacquer.

#### 4. Checking the connection

Check the connection state and quality by the LED signals (see the next Section). In the event of a failure, please refer to Appendix A.

## V. LED Signals

The Device is equipped with a bi-color LED that indicate the Device's state. The Device produces a short single green flash after powering on, indicating that the Device is functioning.

### *1. Signals during normal operation*

During normal operation, Device produces a series of six flashes every five seconds. The Flashes indicate the state of Device interfaces over the last five seconds and have the following meaning:

- **Flash #1.** GREEN if data is received from the NMEA 2000 interface, otherwise RED. Note that filters and other Device settings do not effect this signal. RED usually indicates problems at the level of the physical connection.
- **Flash #2.** GREEN if data transmitted to NMEA 2000. This signal may be RED if nothing was received from NMEA 0183, or conversion was prohibited by the filter settings (see Section VI).
- **Flash #3.** GREEN if data was received from NMEA 0183 interface. A RED signal may indicate the incorrect speed of the NMEA 0183 port or problems with the physical connection.
- **Flash #4.** Checksum signal. GREEN if no checksum error found in incoming NMEA 0183 messages (only messages not blocked by filters are verified). RED if errors were found or nothing was received (Flash #3 is RED).
- **Flash #5.** GREEN if data was transmitted to NMEA 0183. As there is no confirmation of reception, this signal does not mean that data was received by any listener. RED means that Gateway has nothing to send, because nothing was received from NMEA 2000 or everything was prohibited by filters (see Section VI).
- **Flash #6.** Overflow signal. GREEN if no overflow occurs (see VII for details) in the outgoing NMEA 0183 queue. RED if overflow is detected or nothing was transmitted (Flash #5 is RED).

The 4th signal is very important for checking the connection wiring and quality. For example, connecting of TX+ and TX- wires from different ports or even from different devices can remain undetected for a long time. However, when both ports (devices) are transmitting at the same time, the message is corrupted, and a checksum error signal indicates the problem. Electromagnetic noise from power

equipment (fridges, generators, etc.) may also cause a checksum error.

The last (sixth) signal indicates that port speed is too slow for outgoing NMEA 0183 stream. To understand the scale of the problem, you can record and check diagnostics data. See the description of overflow diagnostic messages at Section VII.

## *2. Signals after inserting MicroSD card*

After inserting the MicroSD card into the Device you will see a sequence of three flashes:

- **Three green flashes:** the YDNG.TXT configuration file has been read and changes have been made to the current Device settings and saved to non-volatile memory. The YDNGBSAVE.TXT file on the card has been saved with the updated configuration.
- **Green, red, red:** the YDNG.TXT file has been read from the card, but the current configuration of the Device has not been changed (either the configuration file does not differ from the current settings, contains errors or there are no settings in the file). The YDNGBSAVE.TXT file on the card has been saved with the current configuration.
- **Three red flashes:** the YDNG.TXT was not found on the MicroSD card or the file system is not supported (see section III).

You can safely remove the MicroSD card when the flash sequence is finished.

## *3. Other signals*

LED signals during diagnostics recording and during firmware updates are described in Sections VII and VIII.



## VI. Device Settings

To configure the Device, a text file with the configuration should be created and named YDNG.TXT in the root folder of the MicroSD card. A sample of the configuration file is in Appendix E.

The file contents must conform to these rules:

- parameters and their values must be entered in UPPER CASE;
- each parameter must be on its own line;
- commentary lines must start with the # symbol.

Insert the card with a configuration file into the Device and in a few seconds you will see three LED signals (see Section V) indicating that the configuration file has been processed. A file named YDNGBSAVE.TXT will be created on the memory card with the current configuration of the Device. After the three LED signals, you can remove the card and check the new YDNGBSAVE.TXT file to be sure that the configuration file has been properly interpreted.

You also can load an empty configuration file (zero length) into the Device to get the YDNGBSAVE.TXT file with the full configuration of the Device and then use it as a template to configure the Device.

1. *0183\_SPEED=x*

*Where x – any speed from 300 to 115200 baud with increments of 300.*

*Factory configuration: 4800*

The default speed of a NMEA 0183 port is 4800 baud, but speeds of 9600 (Navtex) and 38400 (AIS) are also widely used. Some equipment has no speed selector, but you can switch the port type between “NMEA”, “Navtex” and “AIS” (or something similar). Even though a port is labeled “AIS” type, usually that only means that it works at 38400 baud and processes not only AIS, but all other NMEA 0183 messages too.

The general rule is that a slower connection is more robust. However, 4800 baud allows transferring of about 480 symbols per second. If equipment send a lot of data (for example, depth, wind, speed, and GPS data) it is possible that the data block will be above 1000 bytes, and that data will be updated

once per two seconds. In the case of 38400 speed, the update rate will be 2 times per second.

Our recommendation is to set the highest possible speed. If you are sure that your equipment does not require high speed, or you see checksum error signals from the LED (see Section V), you can decrease the speed.

A speed above 38400 (57600, 115200) can be used for connection with PC adaptors or NMEA 0183 multiplexers with configurable port speed.

2. *0183\_TX\_TYPE=x, 0183\_RX\_TYPE=x, N2K\_TX\_TYPE=x and N2K\_RX\_TYPE=x*

Where *x* – WHITE or BLACK

Factory configuration: BLACK

Defines the type of filter for messages transmitted to connected NMEA 0183 equipment (0183\_TX\_TYPE), received from connected NMEA 0183 equipment (0183\_RX\_TYPE), transmitted to NMEA 2000 network (N2K\_TX\_TYPE) and received from NMEA 2000 network (N2K\_RX\_TYPE).

See the next two parameters for details.

3. *0183\_TX\_FILTER=x and 0183\_RX\_FILTER=y*

Where *x* and *y* – empty string or the list of 3-char NMEA 0183 sentence formatters separated by a comma.

Factory setting: *x* – DBT,DBS,XDR,DTM,DIN,PGN; *y* – empty string.

These settings define records of filter lists, used to process messages sent (0183\_TX\_FILTER) and received (0183\_RX\_FILTER) from connected NMEA 0183 equipment.

According to the standard, a NMEA 0183 sentence starts with a \$ or ! symbol, followed by a two-character talker ID and a 3-char sentence formatter. These elements are followed by data fields (after the comma). The sentence is finished by a check sum after the \* (asterisk) symbol.

Gateway with factory settings using “YD” talker ID, it can be changed with TALKER\_ID setting (see VI.10).

The Device uses 3-char sentence formatters only for filtering. The following sentences matches to GLL and VDM records (sentence formatters):

```
$GPGLL,4146.5894,N,07029.6952,W,173412.02,A*15  
!AIVDM,1,1,,B,ENK`smq71h@@@@@@@@@@@@@@@@@=MeR6<7rpP00003vf400,4*5F
```

For example, to block processing of only GLL and VDM messages from connected equipment, use the following configuration:

```
0183_RX_TYPE=BLACK  
0183_RX_FILTER=GLL,VDM
```

If the filter is of BLACK type, the Device ignores messages whose sentence formatter matches with one of the filter list records. A WHITE filter passes only matched messages.

To prohibit transmission of any messages to connected NMEA 0183 equipment, set the filter type to WHITE and the list to empty (the same effect as disconnect TX wires):

```
0183_TX_TYPE=WHITE  
0183_TX_FILTER=
```

Messages from connected NMEA 0183 equipment pass the 0183\_RX filter first. Passed messages are converted to NMEA 2000 (see Appendix D) and the resulting NMEA 2000 messages are processed with N2K\_TX filter (see the next parameter). Likewise for the reverse direction.

4. *N2K\_TX\_FILTER=x and N2K\_RX\_FILTER=x*

*Where x – empty string or filter records separated by comma.*

*Factory setting: empty string.*

You should be familiar with the NMEA 2000 Standard (which can be purchased from National Marine Electronics Association, [www.nmea.org](http://www.nmea.org)) to operate with NMEA 2000 filters.

These filters actually contain pairs of 29-bit message identifiers and a mask. The identifier is compared

by processing the NMEA 2000 message identifier, and the second value (mask) defines the comparison concerning which bits are significant.

The identifier contains a PGN (Parameter Group Number, described in NMEA 2000 Standard) and a source device address. You can use decimal and hexadecimal numbers (which start with a 0x prefix).

To simplify defining filters, it is also allowed to set filters using PGN only. The filter string contains records separated by comma. Records contain an identifier and mask separated by space, or a PGN number.

Example of correct filter:

```
N2K_RX_FILTER=0x1FD0700 0x1FFFFFF, 130310, 1 255, 130311
```

This filter matches with messages with PGN 130311 (0x1FD07) sent by the device with address 0, PGN 130310 (sent by any device), messages sent by a device with address 1 (“1 255” is another form of the record “0x000001 0x0000FF”), and PGN 130311 (sent by any device).

To prohibit sending of any messages from NMEA 0183 to NMEA 2000 and allow the opposite direction, use the following settings:

```
0183_TX_TYPE=BLACK
0183_RX_TYPE=WHITE
N2K_TX_TYPE=WHITE
N2K_RX_TYPE=BLACK
0183_TX_FILTER=
0183_RX_FILTER=
N2K_TX_FILTER=
N2K_RX_FILTER=
```

The example above has “doubled” settings. Because all messages received from NMEA 0183 are blocked by the 0183 filter, and transmission of any message to NMEA 2000 is blocked by the N2K filter.

5. *0183\_RTE\_TYPE=x and 0183\_RTE\_FILTER=y*

Where *x* – WHITE or BLACK, *y* - empty string or the list of 3-char NMEA 0183 sentence formatters separated by a comma.

Factory setting: *x* - WHITE, *y* - empty.

These settings are similar to those described in VI.2 and VI.3. This filter defines which sentences received from the NMEA 0183 port should be forwarded to NMEA 0183 output. An empty filter of WHITE type (factory setting) prohibits forwarding. An empty filter of BLACK type allows forwarding of all received messages and turns the Gateway into a NMEA 0183 repeater. A non-empty list puts the Gateway into multiplexer mode, where NMEA 0183 output stream contains a mix of received NMEA 0183 sentences and sentences converted from NMEA 2000 messages.

6. *RAY\_AUTOPILOT=x*

Where *x* – ON or OFF

Factory setting: OFF

Turn on the special support of Raymarine SeaTalk NG autopilots during conversion of autopilot sentences from NMEA 0183 to NMEA 2000. See the section IX for details.

7. *WPT\_AUTO\_CONFIRM=x*

Where *x* – ON or OFF

Factory setting: OFF

When the application is switching to the next waypoint, autopilot asks for confirmation on the pilot head and a chart plotter. This setting allows automatic confirmation of the course changing.

8. *RMB\_N2K\_VARIATION=x*

Where *x* – ON or OFF

Factory setting: OFF

Magnetic variation is required to process an RMB sentence of NMEA 0183. It can be obtained from the NMEA 0183 HDG sentence or, if this sentence is absent, this setting allows use of the variation available in NMEA 2000 messages.

9. *NAV\_DATA\_MAG=x*

Where *x* – ON or OFF

Factory setting: ON

The Gateway sends PGN 129284 “Navigation Data” with true bearings. However, some equipment requires magnetic bearings and ignores messages with true bearings. This setting turns sending of additional PGN 129284 with magnetic bearings on and off.

10. *TALKER\_ID=x*

Where *x* – two letters (AA..ZZ) or --

Factory setting: YD

Some versions of Nobeltec MaxSea and TimeZero (PC and iPad versions) ignore sentences with -- talker ID and you need to change it to something else, for example, to YD or GP. When the TALKER\_ID is set to GP, the sentences sent by the gateway looks like \$GPGLL.

11. *WIND\_CALC=x*

Where *x* – ANY, HDG\_STW, COG\_SOG, HDG\_SOG, DISABLED

Factory setting: ANY

This setting turns calculation of true wind on/off for outgoing NMEA 0183 sentences MWV and MWD.

The wind sensor always measures apparent wind; true wind angle and speed are calculating using SOG or STW data and true wind direction requires COG or heading. A chart plotter (or other device) can join all these data and send calculated values to NMEA 2000, but usually true wind direction, angle and speed are not available.

Historically, STW/HDG are used to calculate true wind. However, this is not correct in places with strong

current, and the «true» value of true wind can be obtained using the SOG/HDG pair. Therefore, our gateways offers four options: SOG/HDG (if you love truth), SOG/COG (if you have GPS only), STW/HDG (if tradition is most important), or you can disable calculations.

In the last case, the gateway reports true wind data to NMEA 0183 only if they are calculated by another device available on the NMEA 2000 network. The default setting ANY means that the gateway will detect what data are available on the network and will calculate true wind data using the best possible option.

## *12. FAST\_HEADING=ON|OFF*

*Factory setting: OFF*

This allows transfer of HDG sentence with 12 Hz frequency (80 milliseconds between messages) for using with radars. Note that this frequency consumes 60% of 4800 baud channel. To use the fast heading at 4800 baud, you will need to turn off all other sentences or all long sentences at least.

## VII. Recording of Diagnostics Data

The Device allows all processing data to be recorded to the MicroSD card for the purpose of diagnostics and configuration.



*Recording of diagnostics data is not a normal operation mode. Recording to the MicroSD card can cause delays in messages processing and some NMEA 2000 messages may be skipped. High-speed MicroSD cards from proven manufacturers can reduce the impact.*

Create a file called YDNG.TXT with the following lines included:

```
DIAGNOSTICS=60  
LOG_FORMAT=TEXT
```

Where 60 is a duration of diagnostics recording in seconds (1 - 3600 is allowed), one minute in the example above. LOG\_FORMAT can have TEXT, 0183 or BINARY values. If this parameter is wrong or omitted, TEXT is used.

Note that the given settings are not saved in the non-volatile memory and will no longer apply after the card is removed or when the NMEA 2000 network is powered off or if the recording finishes after a specified time.

Insert the MicroSD card into the Device. The Device will produce a 1-second green LED flash that indicates that recording has started.

Do not eject the card during recording, or the recording will be lost and the file system of the MicroSD card may be corrupted. The Device will inform you with a 1-second red flash of the LED that recording is finished. After this, the memory card can be safely removed from the Device.

In case of BINARY format, the file called YDNGLOG.CAN is creating. It contains NMEA 2000 messages only. To view, convert or export .CAN files, you may use the free CAN Log Viewer program, which works on Microsoft Windows, Mac OS X and Linux: [http://www.yachtd.com/products/can\\_view.html](http://www.yachtd.com/products/can_view.html)

The .CAN file format is open and described in the CAN Log Viewer documentation.



In case of TEXT log format, the file YDNGLOG.TXT is created. Here is an example of the file contents:

```
06:24:46.758 R 09FD0205 1E AE 01 AA F0 FA FF FF
06:24:46.761 T NMEA0183 !AIVDM,1,1,,B,148KQN7P0JQ7Vv0OSCqngOwLJDQP,0*6D
!AIVDM,1,1,,B,139Fb6002817Eo2OoELBIQsJHDQP,0*5F
06:24:46.800 R 09F10D00 00 F8 FF 7F 7C 04 FF FF
06:24:46.831 R 1DEFFF01 40 0A E5 98 B6 06 04 04
06:24:46.980 T NMEA0183 $--DTM,W84,,0000.0000,N,00000.0000,E,0.00,W84*78
$--GLL,5514.9091,N,01459.8328,E,042446.74,A,A*71
$--ZDA,042446.97,10,05,2016,02,00*7C
$--MWV,353.4,R,4.4,M,A*3F
06:24:47.057 R 19FA04A3 21 22 42 48 0D 00 00 00
06:24:47.059 R 19FA04A3 22 00 F2 17 C5 22 DC 35
06:24:47.062 R 19FA04A3 23 F0 0A 00 00 00 00 F2
06:24:47.063 R 19FA04A3 25 00 00 00 00 F2 07 97
06:24:47.065 R 19FA04A3 27 00 00 F2 02 8B 18 65
06:24:47.067 R 19FA04A3 29 F2 10 51 0E 16 31 F0
06:24:47.659 R NMEA0183 $ECDTM,W84,,0.000000,S,0.000000,W,0.00,W84*41
```

'R' and 'T' (after the record time) indicating the message direction (transmitted or received by Gateway), 'NMEA0183' indicates block of lines (or a line) with NMEA 0183 messages and other lines contains NMEA 2000 messages (29-bit identifier and 1 - 8 data bytes in hexadecimal).

In case of 0183 format, the file YDNGLOG.TXT will contains only NMEA0183 records. This format is preferred if you need to verify NMEA 0183 stream only.

In both TEXT and 0183 formats, the file can contains the records like:

```
07:34:10.921 T NMEA0183 Overflow, TX cycle 5.2 seconds
08:11:25.004 T NMEA0183 Overflow, TX cycle 9.3 seconds, some of the AIS
                messages are lost
09:15:12.380 T NMEA0183 Overflow, 310 bytes are lost, check routing settings
```

All these messages indicate that the Gateway is trying to send more data to NMEA 0183 than allowed by the port speed. The sixth LED flash will appear red if there is overflow (see V.1).

NMEA 2000 messages have different rates, some data arrives ten times per second and some data arrives once per minute. The Gateway stores received data in memory, and uses them to generate output NMEA 0183 messages in a cycle. Heading (HDG), depth (DPT), wind (MWV) and COG/SOG (VTG) are sent two times per cycle, other messages are sent once.

If the port speed is high enough, the Gateway does up to two cycles per second. If the cycle takes more than 2.5 seconds, the overflow LED signal is generated and the overflow record (1st line in the example above) is added to the log file.

AIS equipment uses 38400 baud NMEA 0183 connection. If a Gateway's NMEA 0183 port is set to a lower speed, or also used to transfer other data, it may not be enough in areas with extensive navigation.

AIS messages received from NMEA 2000 are stored in a dedicated buffer and are sent to NMEA 0183 during the cycle and extend cycle time. In an area with extensive navigation, you may start to receive overflow signals and overflow records (2nd line in the example) will mention that some AIS data are lost.

NMEA 0183 data is forwarded from the NMEA 0183 input of the Gateway to the NMEA 0183 output (off in the factory setting, see VI.5) and has a dedicated buffer, sending to NMEA 0183 during the cycle and extending the cycle time. Overflow signals and overflow records (3rd line in the example) are generated if the speed of port is not enough.

The only recommendation to solve overflow errors is to prohibit unnecessary sentences with filters (see VI.2 – VI.5).

## VIII. Firmware Updates

In the root folder of the MicroSD card with FAT or FAT32 file system, copy NUPDATE.BIN, which contains the firmware update of the Device. Insert the card into the Device and turn on the power in the NMEA 2000 network.

For 5-15 seconds after powering on, the LED will flash 5 times with a green light. This indicates that the firmware update is successfully completed.

If the Device is already using the given version of the firmware, or if the Device cannot open the file or the file is corrupted, the boot loader will immediately transfer control to the main program. This is done without visual cues.

The Device information including the firmware version is displayed in the list of NMEA 2000 devices (SeaTalk NG, SimNet, Furuno CAN) or in the common list of external devices on the chart plotter (see the third line in Figure 1 on the next page). Usually, access to this list is in the Diagnostics, External Interfaces or External devices menu of the chart plotter. You can also get the actual firmware version from the first lines of YDNGSAVE.TXT file (see Section VI).

Raymarine

Diagnosics

### Select Device

Press to show diagnostic data for all devices: **Show All Data**

Device	Serial No	Network	Software
Digital Radome	E92129 0240451	SeaTalkHS	1.04
<b>Raymarine p70 Display</b>	<b>0140299</b>	<b>STng</b>	<b>2.12</b>
YDNG-03	00800223	STng	1.01 20/04/2018
i50 Tridata Instrument	0130213	STng	1.06
E22158-SeaTalk-STNG-Converter	1034742	STng	1.21
YDBC-05	00005027	STng	1.2 27/02/2015
Raymarine EV-1 Course Computer	0240651	STng	1.01 (RSCP V1 L4)

Standby Radar Tx Sonar GPS Fix

Figure 1. Raymarine c125 MFD devices list with Gateway (YDNG-03)

## IX. Autopilot Control and Settings

This chapter describes how to control NMEA 2000 (SeaTalk NG) autopilot from the application using NMEA 0183 protocol.

Modern autopilots have the following modes:

- **Standby.** In this mode, autopilot is not engaged to the vessel control.
- **Auto.** The autopilot has a fixed course to steer.
- **Wind.** The autopilot steers the boat at a specified angle to the wind.
- **Waypoint.** The autopilot steers the boat to the specified waypoint.
- **Route or Track.** The autopilot steer the boat by a specified route.

The difference in the last two modes is that autopilot not only maintains the right direction to the waypoint, but also tries to follow the line from the previous to the next waypoint.

When NMEA 2000 autopilot is controlled from a NMEA 0183 application, it must receive:

- position of the destination waypoint (from RMB sentence);
- course from the position to the destination waypoint (APB and/or RMB);
- cross track error, means the distance and direction from the current position to the route (APB and/or RMB and/or XTE).

Depending on the implementation, the NMEA 2000 autopilot can also use the following data (and not only):

- vessel heading (HDG sentence), but in most systems the heading sensor is connected directly to the autopilot;
- rate of turn (ROT sentence);
- position, course and speed over ground (RMC sentence).

To control the autopilot, Gateway should receive RMB sentence from the application at least, and APB and XTE if possible. Gateway also needs to have magnetic variation data, which can be obtained from HDG

or RMC sentence or from the NMEA 2000 messages (must be turned on in the Gateway settings).

If your NMEA 2000 network has GPS data, it can use data already available on NMEA 2000 and sending of the ROT, HDG and RMC sentences from the application may not be required. It is better to send minimal data from a PC to the NMEA 2000 network if possible.

Depending on the autopilot sensitivity settings, autopilot can control your vessel smoothly or aggressively. The application only provides the situation (where is the waypoint and how far we are from the route), but the course to steer and the rudder angle are defined by the autopilot logic.

Switching of waypoints is the work of the application. If the arrival radius is set to 1 NM, application can switch to the next waypoint when the current point is still a mile away. If your route is circular or approximately so, the application can unexpectedly switch from the first point to the last. You should be familiar with your application settings and test how the system works on the open water.

The autopilot can warn you or ask for your confirmation when the application changing the waypoint. It depends on autopilot settings. When the application terminates the navigation, it usually stops sending APB and RMB sentences. Autopilot usually switches to Auto mode and signals about that.

Raymarine autopilots use proprietary messages to control. The Gateway was tested with the two systems, but we also expect that it will work well with all other Raymarine SeaTalk NG autopilots:

- Raymarine C90W chartplotter, Raymarine SPX SmartPilot SPX30 and Raymarine ST70 Pilot Head;
- Raymarine c125 chartplotter (LightHouse 17), Raymarine EV-1 Course Computer and Raymarine ACU200 Actuator Unit.

To control Raymarine autopilot:

- its support must be turned on in the settings (see VI.6), because it is turned off by default;
- autopilot must be initially set to the Auto mode to be controlled from the application;
- the application must provide RMB sentence;
- the application should provide an HDG or RMC sentences or using of NMEA 2000 variation must be on in the settings (see VI.8);

- sending of magnetic navigation data must be turned on (see VI.9).

When the route or waypoint is activating in the application, autopilot switches to the Track mode from Auto. If automatic confirmations are off (default settings, see VI.7), the chart plotter and pilot head will ask for the confirmation when waypoint is changing. When the application terminates the navigation, autopilot returns to the Auto mode.

It is impossible to switch from Track mode to Auto when the application controls the autopilot, because it will return it to the Track mode after a 5-second delay. To take control in an emergency, switch the autopilot to Standby mode.

## Appendix A. Troubleshooting

Situation	Possible cause and correction
LED does not signal after the NMEA 2000 network is powered on	<p><b>1. No power supply on the bus.</b> Check if the bus power is supplied (NMEA 2000 network requires a separate power connection and cannot be powered by a plotter or another device connected to the network).</p> <p><b>2. Loose connection in the power supply circuit.</b> Treat the Device connector with a spray for cleaning electrical contacts. Plug the Device into another connector.</p>
First flash in 6-flashes sequence (NMEA 2000 RX) is RED	<p><b>1. Loose connection in the data circuit.</b> Treat the Device connector with a spray for cleaning electrical contacts. Plug the Device into another connector.</p> <p><b>2. There are problems in the NMEA 2000 network.</b> The network segment is not connected to the plotter or there are missing terminators in the network. Plug another device into the selected connector and make sure it appears in the list of devices on the plotter.</p>
Third flash in 6-flashes sequence (NMEA 0183 RX) is always RED	<p><b>1. Wrong port speed.</b> Get sure, that Gateway port speed matches with equipment speed (see Section VI.1).</p> <p><b>2. Wrong wiring.</b> Check the connection schema (Section II.1, Figure 2) and wire colors (Section IV.3, Table 1).</p>
Sixth flash in 6-flashes sequence (TX overflow) is RED	<p><b>1. Port speed is too low.</b> Increase the speed of Gateway's port (see VI.1) and speed of connected equipment if possible.</p> <p><b>2. Too much data.</b> Read Section VII to learn how to diagnose and solve the problem.</p>
Device does not work as expected	Record diagnostics data in TEXT format (Section VII) and apply to technical support.



## Appendix B. Device Connectors

V+, V- - Battery 12V; CAN H, CAN L - NMEA 2000 data;  
SCREEN - Not connected in the Device.

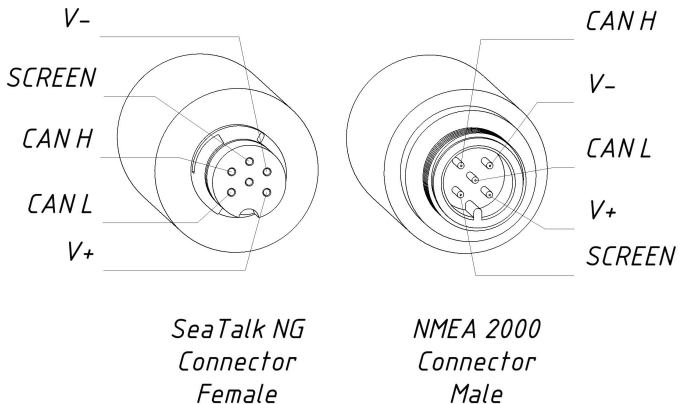
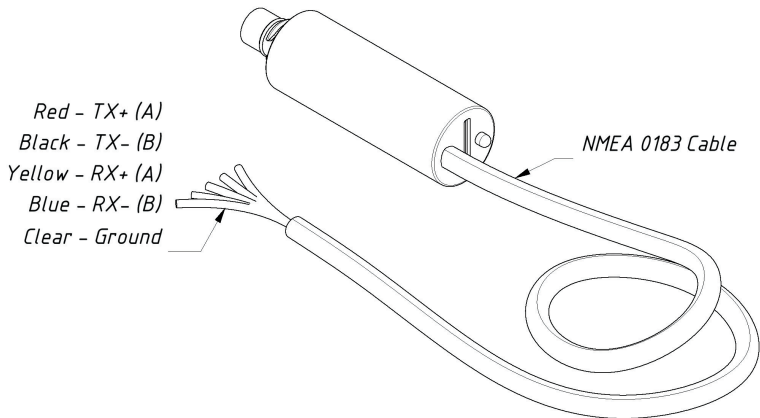

Figure 1. NMEA 2000 connectors of the YDNG-03R (left), and connectors of the YDNG-03N (right) models



*Figure 2. Colors of the NMEA 0183 cable wires*

## Appendix C. NMEA 2000 Messages Supported by Device

This appendix contains messages used in service communication with other devices on the network. “No” in the table below means that the Device will not process or send these messages during service communication with other devices. Note that service communications are not affected by the filter settings of the Device (see Section VI).

Appendix D contains the list of messages processed during conversion from NMEA 2000 to NMEA 0183 and from NMEA 0183 to NMEA 2000.

*Table 1. Messages supported by Device*

<b>Message</b>	<b>Receive</b>	<b>Transmit</b>
ISO Acknowledgment, PGN 59392 (0xE800)	Yes	Yes
ISO Request, PGN 59904 (0xEA00)	Yes	No
ISO Transport Protocol (DT), PGN 60160 (0xEB00)	Yes	No
ISO Transport Protocol (CM), PGN 60416 (0xEC00)	Yes	No
ISO Address Claim, PGN 60928 (0xEE00)	Yes	Yes
ISO Commanded Address, PGN 65240 (0xFED8)	Yes	No
NMEA Group Function, PGN 126208 (0x1ED00)	Yes	Yes
PGN List (Received / Transmitted), PGN 126464 (0x1EE00)	No	Yes
Heartbeat, PGN 126993 (0x1F011)	No	Yes
System Time, PGN 126992 (0x1F010)	Yes	No
Product Information, PGN 126996 (0x1F014)	No	Yes
Configuration Information, PGN 126998 (0x1F016)	No	Yes
GNSS Position Data, PGN 129029 (0x1F805)	Yes	No
Local Time Offset, PGN 129033 (0x1F809)	Yes	No

*Note: NMEA 2000 Device Instance, System Instance, Installation Description Field 1 and Installation Description Field 2 can be changed with PGN 126208. It may be supported by some models of chart plotters or this can be done with professional PC software (with a hardware connector to the NMEA 2000 network). If you have Yacht Devices NMEA 2000 Wi-Fi Gateway or Yacht Devices NMEA 2000 USB Gateway, you can download our free CAN Log Viewer software (runs on Microsoft Windows, Mac OS X and Linux) at <http://www.yachtd.com/downloads/>*

## Appendix D. Conversions Between NMEA 2000 and NMEA 0183

Table 1. Conversions from NMEA 2000 to NMEA 0183

NMEA 2000 PGN	NMEA 0183 Sentence	Comment
65311 Magnetic Variation (Raymarine Proprietary)	—	See note (4)
126992 System Time	ZDA, GLL	See also PGN 129033
127237 Heading/Track Control	APB	Use PGN 129284, 129283 if possible
127245 Rudder	RSA	Two rudders supported
127250 Vessel Heading	HDG, HDM, HDT	See note (4)
127251 Rate of Turn	ROT	
127258 Magnetic Variation	—	See note (4)
127488 Engine Parameters, Rapid Update	RPM, XDR, DIN, PGN	See note (6)
127489 Engine Parameters, Dynamic	XDR, DIN	See note (6)
127493 Transmission Parameters, Dynamic	DIN, PGN	See note (6)
127505 Fluid Level	DIN, PGN	See note (6)
127508 Battery Status	DIN, PGN	See note (6)
128259 Speed, Water referenced	VHW	Also may be used in RMC, VTG
128267 Water Depth	DBT, DBS, DPT	DBS, DPT are off in factory settings
128275 Distance Log	VLW	

Table 1 continued

<b>NMEA 2000 PGN</b>	<b>NMEA 0183 Sentence</b>	<b>Comment</b>
129025 Position, Rapid Update	GLL	Also use PGN 126992 or 129029
129026 COG & SOG, Rapid Update	VTG	Also used in RMC
129029 GNSS Position Data	GGA, GLL, RMC, ZDA	See also PGN 129033
129033 Local Time Offset	—	Time offset is used in ZDA
129044 Datum	DTM	
129283 Cross Track Error	XTE	
129284 Navigation Data	RMB	Use 129283, 129029 if possible
129285 Navigation — Route/WP information	—	Waypoint names from this message are used in RMB and APB sentences
129291 Set & Drift, Rapid Update	VDR	
129539 GNSS DOPs	GSA	PGN 129540 is also required
129540 GNSS Sats in View	GSV	
130066 Route and WP Service — Route/WP— List Attributes	RTE	Use waypoints from 130067
130067 Route and WP Service — Route — WP Name & Position	WPL	
130074 Route and WP Service — WP List — WP Name & Position	WPL	
130306 Wind Data	MWD, MWV	See note (3). Also used in MDA.
130310 Environmental Parameters	XDR, MTW, MDA	See note (1), (5)

Table 1 continued

<b>NMEA 2000 PGN</b>	<b>NMEA 0183 Sentence</b>	<b>Comment</b>
130311 Environmental Parameters	XDR, MTW, MDA	See notes (1), (2), (5)
130312 Temperature	XDR, MTW, MDA	See notes (1), (2), (5)
130313 Humidity	XDR, MDA	See notes (1), (2), (5)
130314 Actual Pressure	XDR, MDA	See notes (1), (2), (5)
130316 Temperature, Extended Range	XDR, MTW, MDA	See notes (1), (2), (5)
129038 AIS Class A Position Report	VDM, VDO	AIS VHF messages 1, 2 and 3
129039 AIS Class B Position Report	VDM, VDO	AIS VHF message 18
129040 AIS Class B Extended Position Report	VDM, VDO	AIS VHF message 19
129041 AIS Aids to Navigation (AtoN) Report	VDM, VDO	AIS VHF message 21
129793 AIS UTC and Date Report	VDM, VDO	AIS VHF messages 4 and 11
129794 AIS Class A Static and Voyage Related Data	VDM, VDO	AIS VHF message 5
129798 AIS SAR Aircraft Position Report	VDM, VDO	AIS VHF message 9
129809 AIS Class B "CS" Static Data Report, Part A	VDM, VDO	AIS VHF message 24
129810 AIS Class B "CS" Static Data Report, Part B	VDM, VDO	AIS VHF message 24

*Note (1):* Air, dew point, inside (saloon) and water temperature, inside and outside humidity, barometric pressure are supported.

*Note (2):* Only messages with data instance 0 are converted.

- Note (3):* Devices with factory settings perform conversion from true to apparent wind. The MWV sentence is sent twice (one for apparent wind and one for true). See VI.11 for details.
- Note (4):* Magnetic variation is used in RMC, HDT, HDG, VDR, VHW, VTG. Priority of variation PGNs: 127250, 127258, 65311.
- Note (5):* MDA is sent only when air, dew point or water temperature, or barometric pressure or outside humidity are available. Also contains wind speed and direction.
- Note (6):* DIN and PGN are wrap NMEA 2000 messages according SeaSmart (v1.6.0) and MiniPlex (v2.0) specifications. Engine revolutions, boost pressure, coolant temperature, hours, fuel rate, alternator voltage are also transmitted in XDR sentence. DIN, PGN and XDR sentences are off in the factory settings (see VI.3).



Table 2. Conversions from NMEA 0183 to NMEA 2000

NMEA 0183 Sentence	NMEA 2000 PGN	Comment
APB	129283 Cross Track Error	Also used in PGN 129284
DIN	127488 Engine Parameters, Rapid Update 127489 Engine Parameters, Dynamic 127493 Transmission Parameters, Dynamic 127505 Fluid Level 127508 Battery Status	According SeaSmart.Net protocol specification v1.6.0
DPT	128267 Water Depth	
DTM	129044 Datum	
GGA	129029 GNSS Position Data	ZDA or RMC are required
GLL	129025 Position, Rapid Update	See note (7)
HDG	127250 Vessel Heading	
HDM, HDT	127250 Vessel Heading	Use variation and deviation from HDG
MWV	130306 Wind Data	Theoretical wind sent as ground referenced to True North; calculated using COG/SOG
RMB	129283 Cross Track Error 129284 Navigation Data 129285 Navigation – Route/WP information	Use data from APB; PGN 129284 sent twice with true and magnetic bearings (see VI.9)
RMC	126992 System Time 127258 Magnetic Variation 129025 Position, Rapid Update 129026 COG & SOG, Rapid Update	See note (7)

Table 2 continued

<b>NMEA 0183 Sentence</b>	<b>NMEA 2000 PGN</b>	<b>Comment</b>
RSA	127245 Rudder	
RTE	130066 Route and WP Service – Route/WP-List Attributes 130067 Route and WP Service – Route - WP Name & Position	Use data from WPL
ROT	127251 Rate of Turn	
VHW	128259 Speed, Water referenced	
VDR	129291 Set & Drift, Rapid Update	
VLW	128275 Distance Log	
VTG	129026 COG & SOG, Rapid Update	
WPL	130074 Route and WP Service – WP List – WP Name & Position	Only waypoints not included to the route (the RTE should be received during 3 seconds after WPL).
XTE	129283 Cross Track Error	
ZDA	126992 System Time 129033 Local Time Offset	

Table 2 continued

NMEA 0183 Sentence	NMEA 2000 PGN	Comment
VDO, VDM	129038 AIS Class A Position Report 129039 AIS Class B Position Report 129040 AIS Class B Extended Position Report 129041 AIS Aids to Navigation (AtoN) Report 129793 AIS UTC and Date Report 129794 AIS Class A Static and Voyage Related Data 129798 AIS SAR Aircraft Position Report 129809 AIS Class B "CS" Static Data Report, Part A 129810 AIS Class B "CS" Static Data Report, Part B	AIS VHF messages 1, 2 and 3 AIS VHF message 18 AIS VHF message 19 AIS VHF message 21 AIS VHF messages 4 and 11 AIS VHF message 5 AIS VHF message 9 AIS VHF message 24 AIS VHF message 24

*Note (7): All NMEA 2000 periodic messages are sending with interval specified in the Standard. Except PGN 127488, 127489, 127493, 127505 and 127508, these messages are sending immediately on receiving of DIN sentence.*

*Note (8): Sentences with no significant data (or data marked as invalid) may not be translated to NMEA 2000 messages. NMEA 0183 sentences with invalid check sum are ignored.*

## Appendix E. Example of Configuration File

Contents listed below of the file correspond to the factory settings.

```
# Current configuration of Yacht Devices NMEA 0183 Gateway YDNG-03
# Firmware: 1.03 06/08/2018

# Default speed 4800, Navtex 9600, AIS 38400 (recommended)
0183_SPEED=4800

TALKER_ID=YD
WIND_CALC=ANY
FAST_HEADING=OFF

# Filter type (WHITE or BLACK)
0183_TX_TYPE=BLACK
0183_RX_TYPE=BLACK
N2K_TX_TYPE=BLACK
N2K_RX_TYPE=BLACK

# Filter definition, examples for 0183 and N2K:
#
# 0183_TX=GLL, VDO, VDM, DPT
# N2K_RX=0x1FD0700 0xFFFFFFFF, 130310, 1 255, 130311
#
0183_TX_FILTER=DBT,DBS,XDR,DTM,DIN,PGN
0183_RX_FILTER=
N2K_TX_FILTER=
N2K_RX_FILTER=

# Filter for data forwarding from the NMEA 0183 RX to NMEA 0183 TX
# An empty WHITE filter prohibits forwarding of all data
0183_RTE_TYPE=WHITE
```

```
0183_RTE_FILTER=  
  
# Autopilot  
RAY_AUTOPILOT=OFF  
WPT_AUTO_CONFIRM=OFF  
RMB_N2K_VARIATION=OFF  
NAV_DATA_MAG=ON  
  
# End of file
```





